

# Appendix

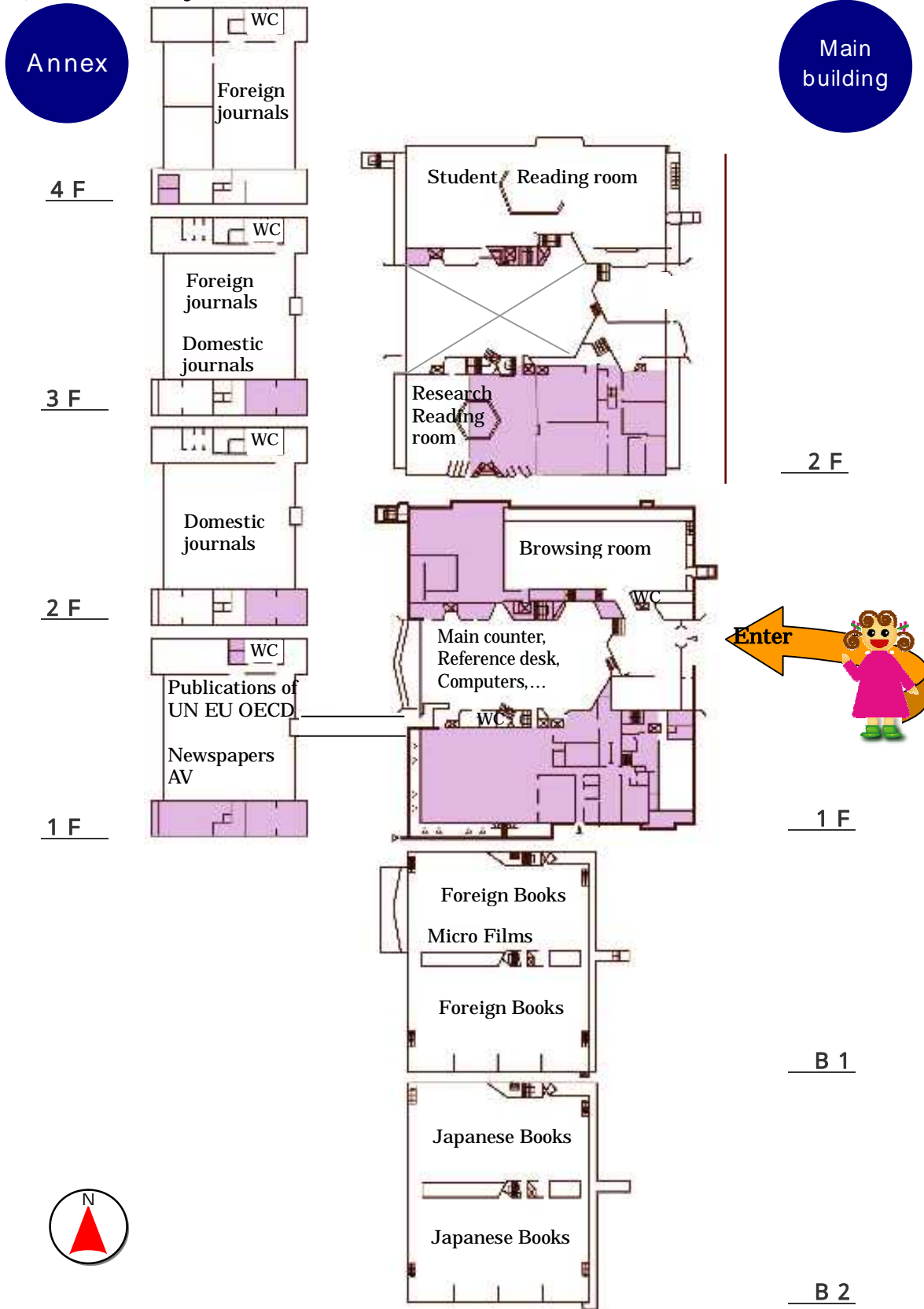

# Appendix 1 Floor Map

## 1) Main Library



2) Medical Library

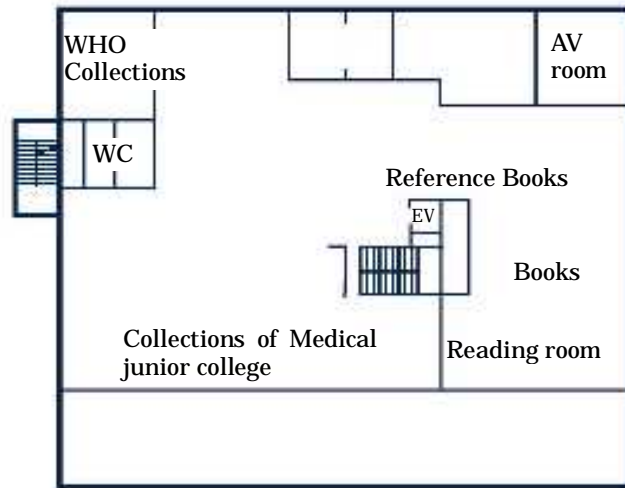

3 F

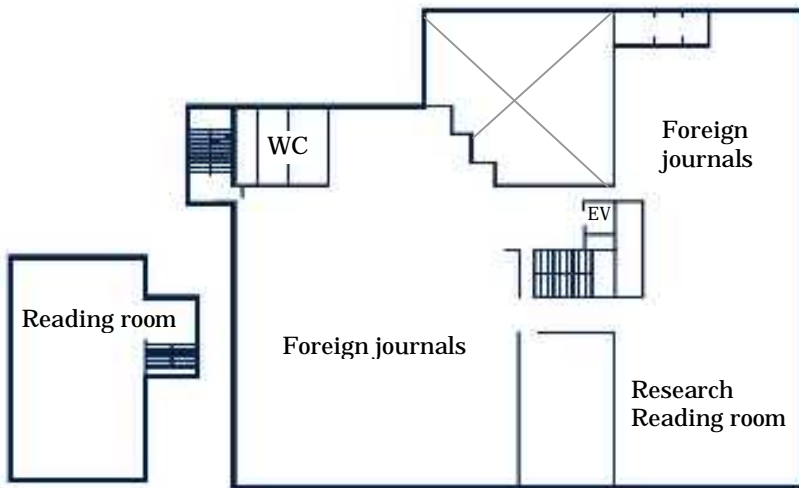

2 F

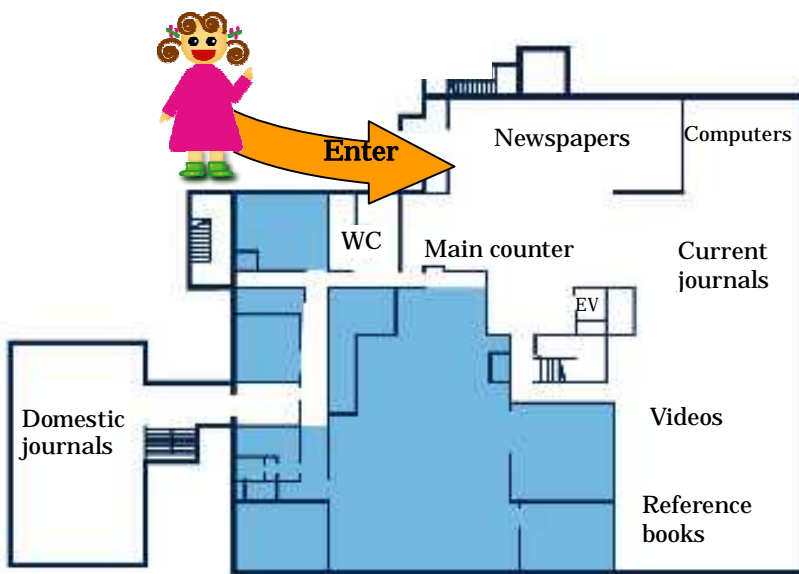

1 F

3) Kita-Aobayama Library

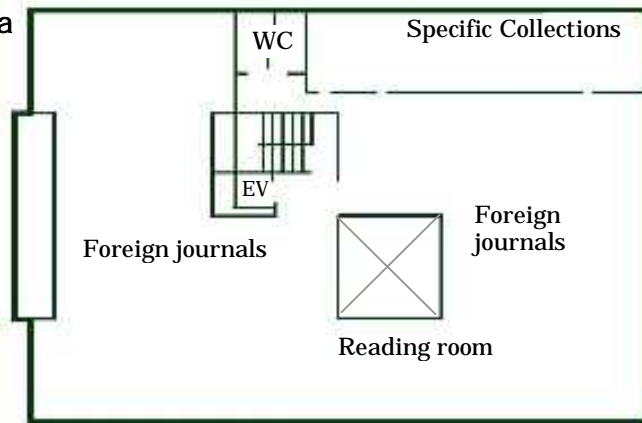

3 F

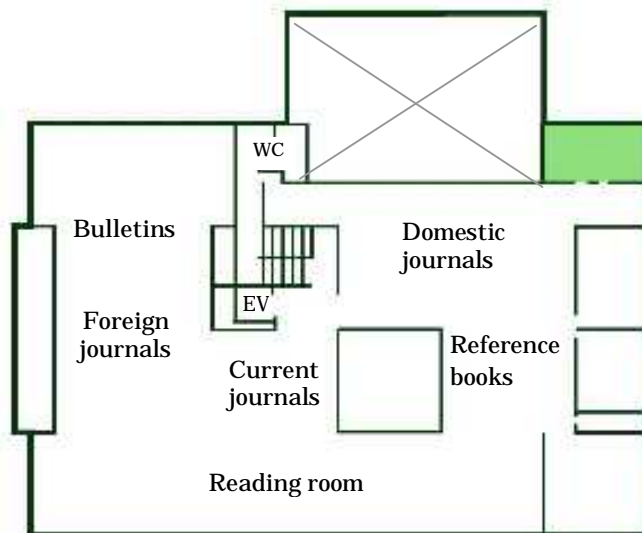

2 F

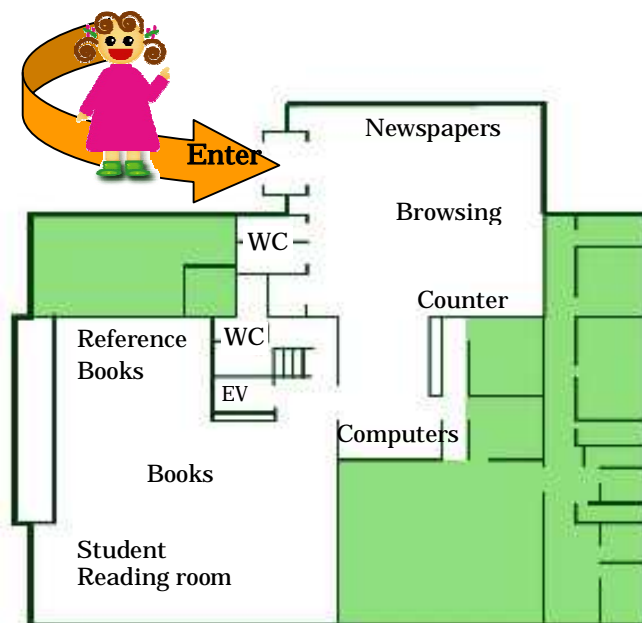

1 F



#### 4) Engineering library

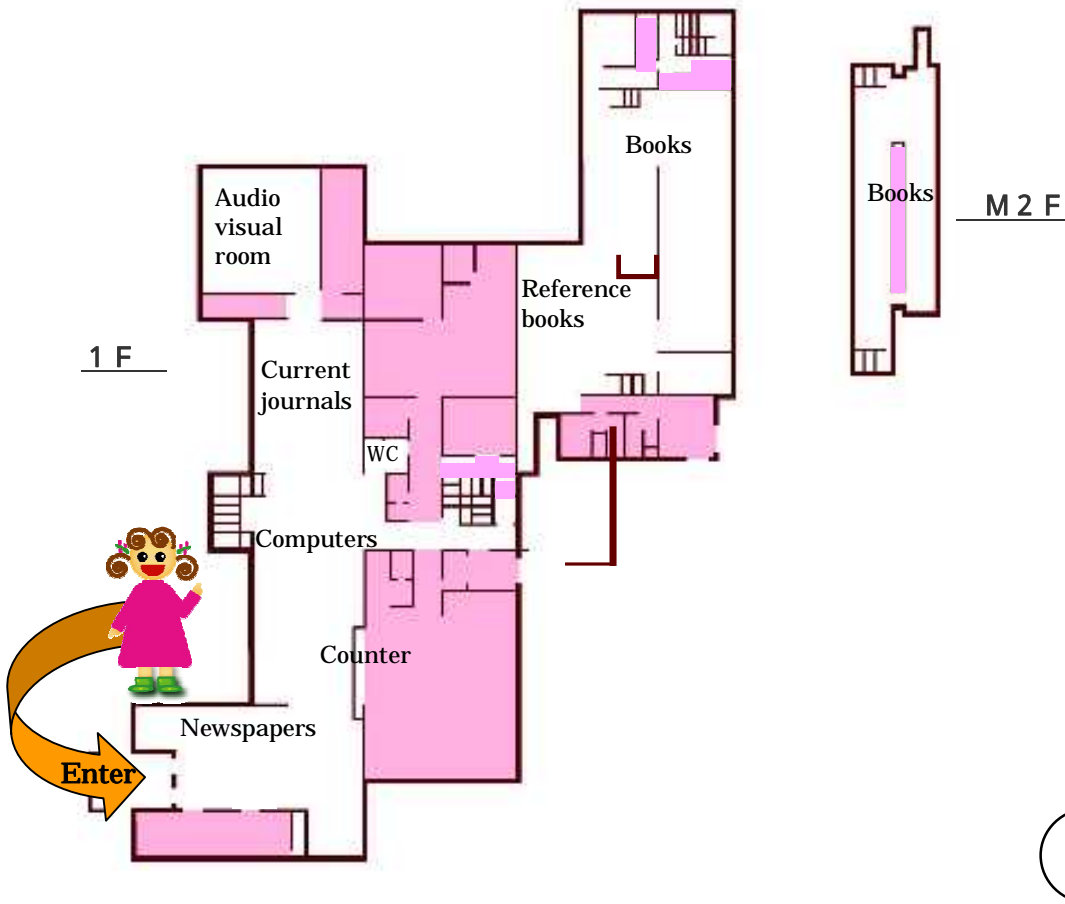
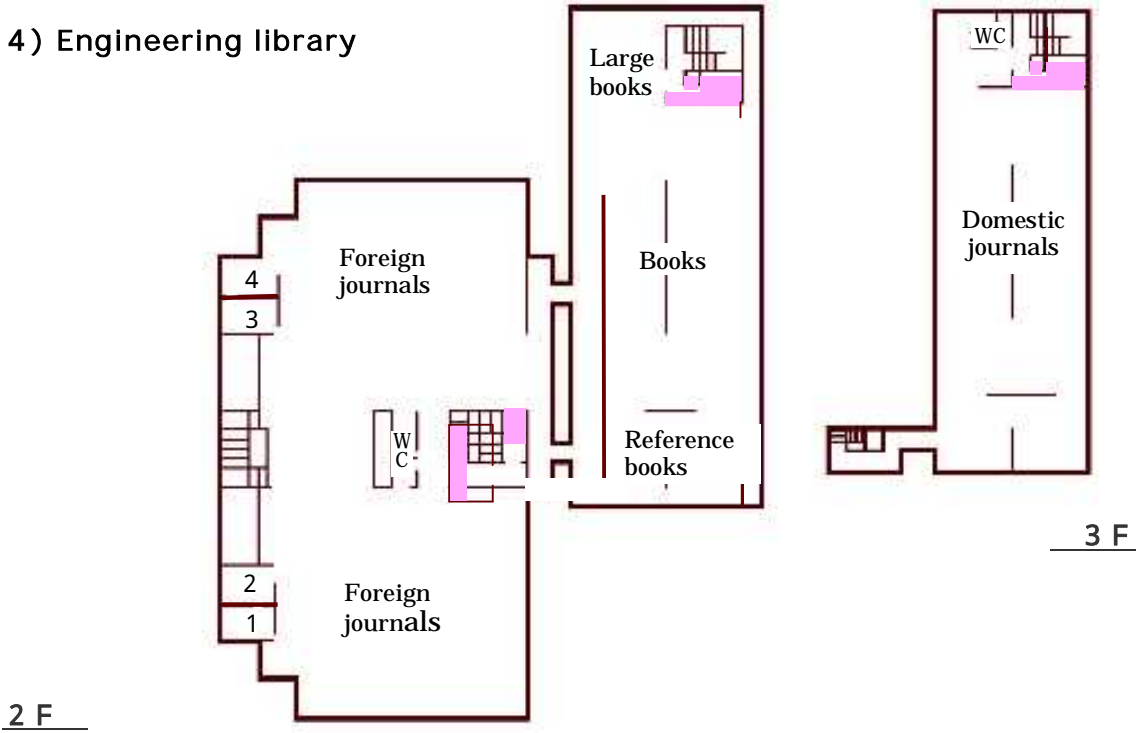

### 5) Agricultural library

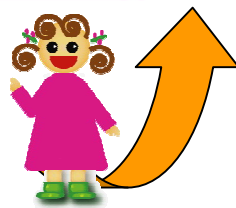
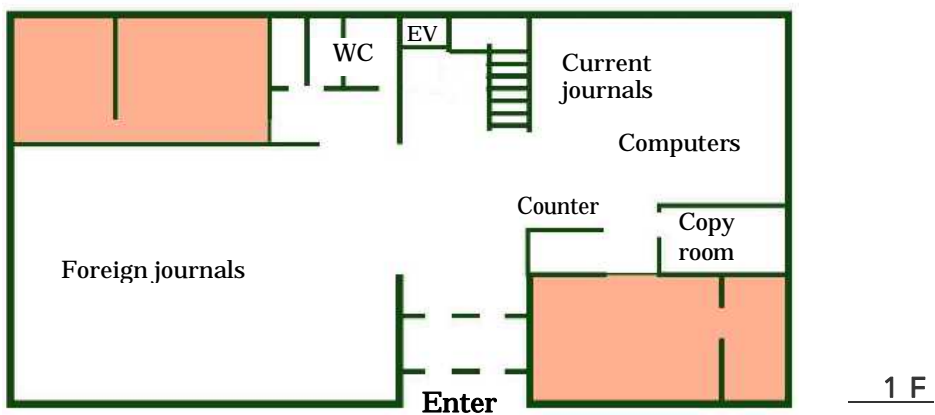
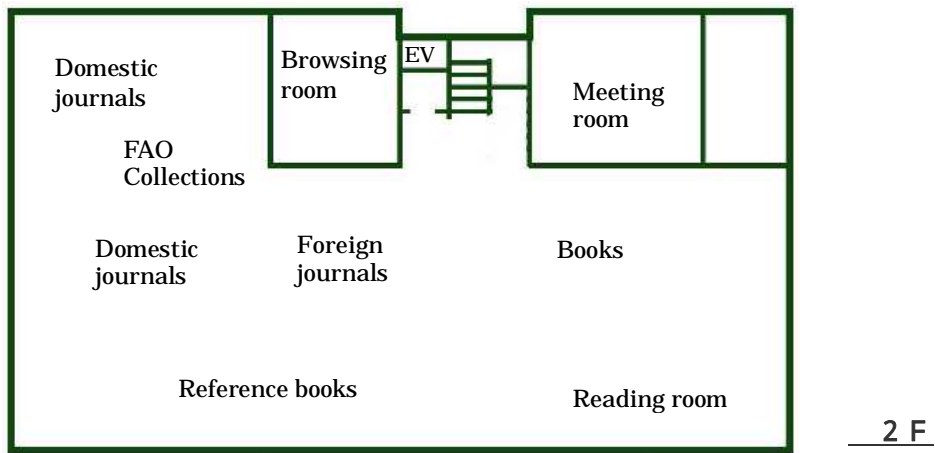

## Appendix 2 About Japanese Universities and Libraries

### 2.1 Japanese Universities

In Japan, there are National, Public (Prefectural / Municipal, etc.) and Private Universities. They all have libraries of their own, and the libraries are associated with each other to act cooperatively. They make efforts jointly to provide a high quality library service, Interlibrary loans, e-DDS, online references, an integrated system and so on.

Number of Universities in Japan (as of April 1, 2008)

• National Univ. . . . . 86

• Public Univ. . . . . 75

• Private Univ. . . . . 593

\*cf. <http://www.mext.go.jp/english/index.htm>

(1) National Universities; Tohoku University, Hokkaido University, University of Tokyo, Kyoto University...

There is one National University in each prefecture at least, including an individual medical college, educational college and so on.

(2) Public Universities; Miyagi University, Tokyo Metropolitan University...

Self-governing bodies organize these universities.

(3) Private Universities; Tohoku Gakuin University, Keio University, Waseda University...

The Organizers of these universities are mainly individuals, and some universities were founded by corporation.

Many Universities have graduate schools, master's degree courses (2 years), and doctoral courses(3 years). In Japan, people graduate high school at age 18, so it's possible to take a doctorate at age 27. Few Universities allow stages in this process to be skipped.

Japanese school (elementary school, junior high school, high school and University or College) begins the new term from April. The calendar of Tohoku University is as follows (in the case of undergraduates 2008):

1st semester (April 1-September 30)		2nd semester (October 1-March 31)	
Spring Vacation	April 1 ~ April 6	Health and Sports Day (Holiday)	2nd Monday of October
Entrance Ceremony	April	Special Orientation for New International Students	October
Special Orientation for New International Students	April	Culture Day (Holiday)	November 3
Showa Day(Holiday)	April 29	Labor Thanksgiving Day(Holiday)	November 3
Constitution Memorial Day(Holiday)	May 3	Emperor's Birthday (Holiday)	December 23
Green Day (Holiday)	May 4	Winter Vacation	December 25 ~ January 5
Children's Day (Holiday)	May 5	New Year's Day (Holiday)	January 1
Annual Health Checkup	May	Coming of Age Day (Holiday)	2nd Monday of January
University Foundation Day	June 22	National Foundation Memorial Day (Holiday)	February 11
Marine Day(Holiday)	3rd Monday of July	Vernal Equinox Day (Holiday)	Mar
Summer Vacation	Aug ~ Sep	Commencement	March
Respect for the Aged Day(Holiday)	3rd Monday of September		
Autumnal Equinox Day(Holiday)	Sep 23		

[http://insc.tohoku.ac.jp/handbook/handbook\\_e/](http://insc.tohoku.ac.jp/handbook/handbook_e/)

In Japan, each university provides a helpdesk or special staff to assist international students in life and to complete their courses. Tohoku University provides *The Center for International Exchange*.

■ See for further information:

[http://www.insc.tohoku.ac.jp/cms/index\\_e.cgi](http://www.insc.tohoku.ac.jp/cms/index_e.cgi)



## 2.2 University Libraries in Japan

Each university has their own library, small colleges have one on campus, but large universities which have several campuses have several libraries. Generally there is a main library and a number of branch libraries in that case. Branch libraries sometimes belong to each faculty.

Members of the University are able to use their library at no charge except for some services (e.g. photocopying). But holidays, opening hours, and circulation rules are differ between libraries. Confirm these informations before visiting a library.

When you became a member of the university, you will get a student ID card. In many Universities, you can use the library with this card, but sometimes you have to make a separate application to get a library card. Ask library staff whether you need to complete a separate procedure to use your library.

## 2.3 How to use other university libraries in Japan

When you use your university's library, there is no problem. On the other hand, when you would like to use another university's library, you need to fulfill the correct procedure before your visit.

If you visit other libraries without contacting them beforehand, you may not be able to use the library.

Although it takes a deal of trouble, ask your library staff about the correct procedure. They will write a letter of introduction if you need one. You can request photocopies of papers from other library via your library .

## Appendix 3 Information Service Institutions

### (1) Japanese Institutions

- National Institute of Informatics (NII)  
(<http://www.nii.ac.jp/index.shtml.en>)
- Japan Science and Technology Agency (JST)  
(<http://www.jst.go.jp/EN/index.html>)
- National Diet Library (NDL) (<http://www.ndl.go.jp/en/index.html>)

### (2) Foreign Institutions

- The British Library (BL) (<http://www.bl.uk/>)

### (3) Data-base Service Institutions

- Thomson Scientific (<http://www.thomsonscientific.jp/>)
- Japan Association for International Chemical Information (JAICI)  
(<http://www.jaici.or.jp/english/>)
- National Library of Medicine (NLM) (<http://www.nlm.nih.gov/>)

### (4) Others

- Japan Patent Office (JPO) (<http://www.jpo.go.jp/>)
- National Center for Industrial Property Information and Training (NCIPI) (<http://www.inpit.go.jp/english/index.html>)
- Japanese Standards Association (JSA)  
([http://www.jsa.or.jp/default\\_english.asp](http://www.jsa.or.jp/default_english.asp))
- International Medical Information Center (IMIC)  
(<http://www.imic.or.jp/>)

## Appendix 4 Abbreviation Table

Abbreviation	Full form
Ann. Annu.	annals / annual / annalen / annale / annali
anon.	anonymous
app.	appendix
arch.	archives
art.	article
Aufl.	auflage
Ausg.	ausgabe
Bd.	band
beil.	beilage
bibl. bibliog.	bibliography
Bull.	bulletin
c.	copyright
c. ca.	circa (=about)
cf.	confer (=compare)
ch. chap. chaps.	chapter
col.	color
col. cols.	column
comp. comps.	compiled by / compiler
conf.	Conference
cong.	Congress
corr.	correction
C.R.	Comptes Rendus
Dept. Depts.	department
Diss.	dissertation
div. divs.	division
do.	ditto
doc.	document
ed. eds.	edited by / edition / editor
ed.cit.	editio citata / edition cited
e.g.	exempli gratia (=for example)
enl. enlgd.	enlarged
et al.	et alia (=and others) et alibi (=and elsewhere)

Appendix

Abbreviation	Full form
fac. facsim.	facsimile
fasc.	fascicle
fig. figs.	figure
hb. hbk.	hardback
hft.	Heft
hg.	herausgeber
hrsg.	herausgegeben
ib. ibid.	ibidem(=in the same place)
id.	idem (=the same)
i.e.	id est (=that is)
ill. illus.	illustrated / illustration
inst.	institute
int.	international
ISBN	International Standard Book Number
ISSN	International Standard Serial Number
izv.	izvestiia / izvestiya
J.	journal
Jahrg.	jahrgang
l. ll.	line
l.c. loc.cit.	loco citato(=in the same place cited)
m.s. MS. mss.	manuscript
N/A	not applicable / not available
n.d.	no date
n.p.	no place / no publisher
n.pag.	no pagination
n. no. nos.	number
n.s. NS	new series / new style
op.cit.	opere citato(=in the work cited)
p. pp.	page
par.	paragraph
Pat.	patent
pb. pbk.	paperback
pl.	plate
proc.	proceedings

Abbreviation	Full form
pt. pts.	part
pub.	published by / publication / publisher
repn. rpt.	reprint / reprinted
rept.	reported by / report
rev.	review
rev.ed.	revised edition
sec. sect. secs.	section
ser.	series
[ <i>sic</i> ]	(=so, thus)
s.l.	sine loco(=no place of publication)
s.n.	sine nomie(=without name)
supp. suppl.	supplement
symp.	symposium
t. tom.	tome
tab.	table
T.O.C.	table of contents
t.p.	title page
t.p.verso	title page verso
T.R.	technical report
tr. trans.	translator / translation / translated
trans.	transaction
v. vol. vols.	volume
Z.	Zeitschrift



## For Further Reading!

Tohoku University Library also provides the following tutorial guide books (Japanese version only).

- 東北大学生のための情報探索の基礎知識 基本編 2009
- 東北大学生のための情報探索の基礎知識 人文社会科学編 2007

You can get these books for FREE. If you want to get them, please apply for the library service counter or see the URL below.

- <http://www.library.tohoku.ac.jp/mylibrary/tutorial/literacy.html>