

Mechanical Properties of Mo and TZM Alloy Neutron-Irradiated at High Temperatures

Kazukiyo Ueda^a, Manabu Satou^b, Akira Hasegawa^b and Katsunori Abe^b

^a Graduate Student, Graduate School of Engineering, Tohoku University

^b Department of Quantum Science & Energy Engineering,
 Graduate School of Engineering, Tohoku University, Sendai 980-77, Japan
 (Received March 28, 1997)

This work reports the mechanical properties of irradiated molybdenum (Mo) and its alloy, TZM. Recrystallized and stress-relieved specimens were irradiated at five temperatures between 373 and 800 °C in FFTF/MOTA to fluence levels of 6.8 to 34 dpa. Irradiation embrittlement and hardening were evaluated by three-point bend test and Vickers hardness test, respectively. Stress-relieved materials showed the enough ductility even after high fluence irradiation. The role of layered structure of stress-relieved specimen was discussed.

KEYWORDS : Molybdenum, Fusion materials, Mechanical properties, Neutron irradiation, Irradiation effect

1. Introduction

High heat flux components of fusion reactor, such as divertor, must withstand exposures to high-energy particles and high thermal load. Therefore, these materials are required to have high melting resistivity, high thermal conductivity and superior mechanical strength at high temperatures. Molybdenum and tungsten are candidate refractory materials for high heat flux components of fusion reactor.¹⁻³

Molybdenum and its alloys have been used for industrial applications in environment at high temperatures. Molybdenum alloy, TZM, was developed to improve grain-boundary strength, and has higher recrystallization temperature. One of issues of Mo and its alloys for fusion application is irradiation-induced embrittlement which leads to increase of ductile-brittle transition temperature (DBTT). Irradiation embrittlement of Mo depended on several metallurgical factors,⁴⁻⁸ such as fabrication process, alloying elements, pre-irradiation heat treatment, and irradiation conditions, such as temperature and fluence. It have been reported that, for Mo irradiated to low fluence (~1 dpa), stress-relief treatment before irradiation was effective to reduce significantly the increase of DBTT compared to recrystallization treatment.⁹

The purpose of this work is to study the effects of thermal treatments and irradiation conditions on mechanical properties of Mo and TZM after neutron irradiation up to high fluence.

2. Experimental

Specimens in shape of disk of 3 mm diameter and 0.25 mm thickness were prepared from powder-metallurgical sheets which were supplied from Metallwerk Plansee. Chemical compositions of the samples reported by supplier are given in Table 1. Before irradiation, specimens were annealed in two conditions, recrystallized (R) and stress-relieved (SR) heat treatments, in an evacuated and sealed quartz tube. The condition and the grain size are shown in Table 2.

Neutron irradiation was performed in the Material Open Test Assembly of the Fast Flux Test Facility (FFTF/MOTA) cycle 11 operation. Specimens were irradiated in stainless steel capsules filled with helium gas. Irradiation conditions are shown in Table 3. The damage levels were calculated for stainless steel by SPECTOR code,¹¹ and converted to Mo. The exposure fluence and irradiation temperature of each capsule depended on the irradiation position in the reactor.

Table 1: Chemical composition

Molybdenum						max. wt. ppm			
Mo	C	N	O	H	Al	Ca	Fe	K	
bulk	30	10	50	5	20	20	100	10	
Na	Ni	P	S	Si	Ti	W	Cr		
10	20	20	20	30	10	300	10		

TZM			wt.%		wt. ppm	
Mo	Ti	Zr	C	O	N	
bulk	0.48	0.10	0.013	4	2	

Table 2: Heat treatments and grain sizes

	Temp. (°C)	Time (min.)	Grain size(μm)
Mo/R	1200	60	20
Mo/SR	926	15	2
TZM/R	1600	60	20
TZM/SR	926	15	2

Table 3: Parameters for irradiation¹⁰

Temp. (°C)	Fluence (> 0.1 MeV, ×10 ²⁶ n/m ²)	Displacement (dpa)
373	1.97	6.8
406	7.47	27
519	9.46	34
600	9.46	34
800	3.19	11

After irradiation, micro Vickers hardness tests were performed to evaluate irradiation hardening with a load of 1.96 N for 20 s at room temperature.

In order to evaluate irradiation embrittlement, three-point bend tests were performed at room temperature. The test fixture is shown schematically in Fig. 1. The testing apparatus apparatus is mounted on an Instron type universal test machine. Bending tests were carried out at cross-head speed of 0.2 mm/min.

After bending test, fracture surfaces were examined by a scanning electron microscope (SEM) to confirm the failure mode.

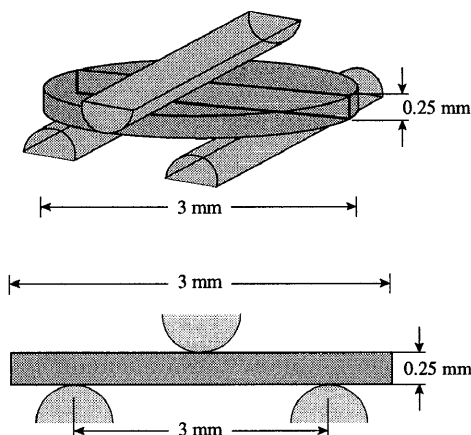

Fig.1 Schematic cross-section of bending test.

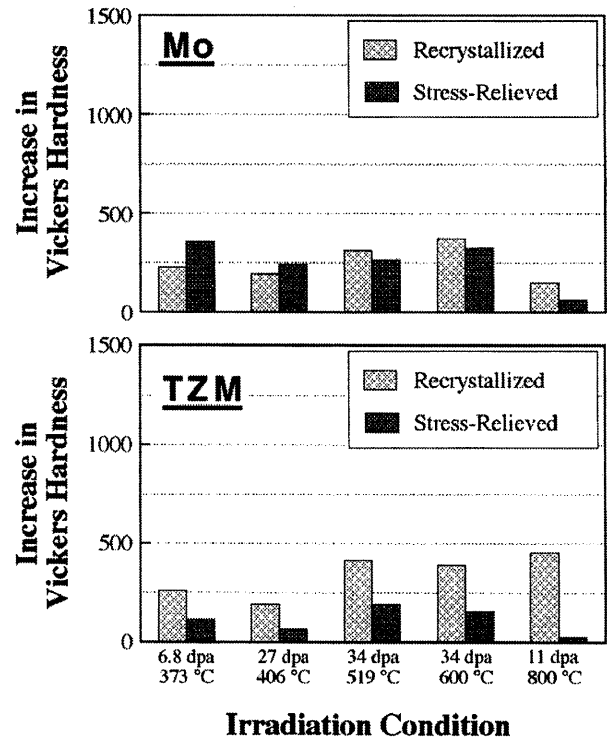

Fig.2 Increase in micro Vickers hardness of Mo and TZM alloy after irradiation.

3. Results and Discussion

3.1. Hardness

The results of hardness increase by irradiation are shown in Fig. 2. Vickers hardness of unirradiated specimens were 185 and 273 for Mo/R and /SR, 209 and 478 for TZM/R and /SR, respectively. Irradiation hardening of recrystallized and stress-relieved Mo showed the same trend to the irradiation conditions.

The irradiation hardening of specimens irradiated in 373 °C/6.8dpa is larger than those in 406 °C/27dpa, even less irradiation damage level. It may be attributed to fine defects distribution produced at lower irradiation temperature. Stress-relieved specimen irradiated in 800 °C/11 dpa shows less irradiation hardening compared to others. It may be attributed to the recovery of dislocation structures during irradiation by stress relief process.

3.2. Bending Tests

Figure 3 shows the result of three-point bending tests for irradiated specimens at room temperatures. Plastic deflection means difference after yield point until fracture.

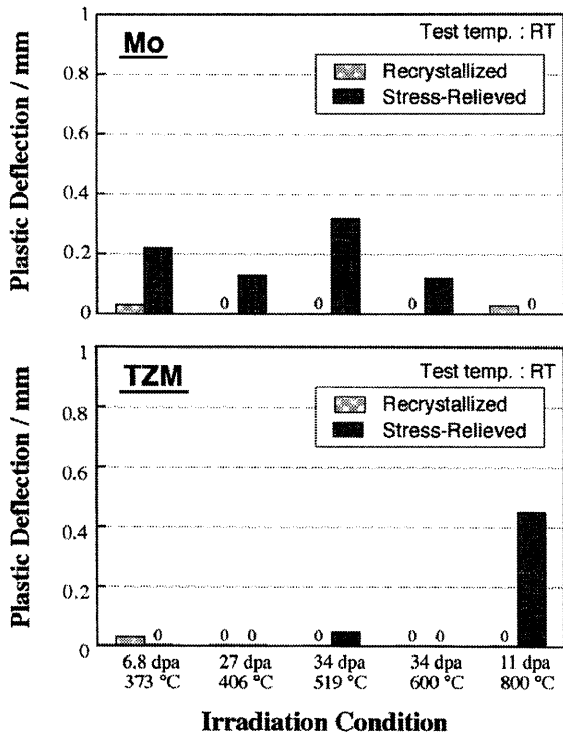

Fig.3 Deflection after yield point on load-deflection curve in bend test, for irradiated (a) Mo and (b) TZM. "0" denotes that a specimen was fractured before yielding.

Stress-relieved Mo showed plasticity in all irradiation conditions except when irradiated at 800 °C. Relatively large deflection was observed when irradiated at 519 °C. For Mo/R, small plastic deflections were observed in specimens irradiated at 373 °C and 800 °C, but in other irradiation conditions fractures occurred before yielding. The plastic deflection of recrystallized Mo were zero or little in all irradiation conditions and it could be inferred that DBTT of Mo/R is above room temperature. These results show that stress-relieved heat treatment before irradiation suppresses irradiation embrittlement and keep Mo ductile at room temperature even after heavy neutron irradiation. Specimen of Mo/SR irradiated at 800 °C, however, fractured in brittle manner even less irradiation damage than for 406~600 °C.

Specimens of TZM/R fractured before yielding in all of irradiation conditions except 373 °C, where a little plastic deflection was measured. These brittle behavior indicates that DBTT of TZM/R after irradiation is above room temperature, as well as of Mo.

In contrast, eminent deflection was measured when

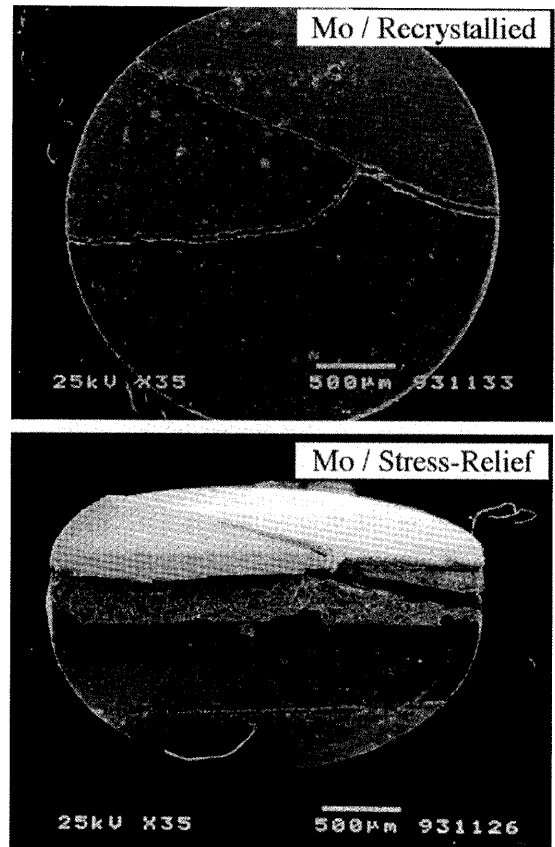

Fig.4 Tensile-side surface after bending test of (a) Mo/R and (b) Mo/SR irradiated in 406 °C/27 dpa.

irradiated at 800 °C for TZM/SR. In other irradiation conditions, TZM/SR fractured with slight or no plastic deflection. DBTT of stress-relieved TZM after irradiation may be in the range of room temperature or higher, but not so high as for TZM/R.

Stress-relief heat treatment is effective to suppress irradiation embrittlement for both Mo and TZM. The effectivity depends on alloying elements and irradiation temperatures.

3.3. Fractography

For specimens ruptured in bending test, fracture surfaces of specimens were observed using SEM to identify failure mode.

Surfaces of tensile side of ruptured Mo/R and Mo/SR irradiated in 406 °C/27 dpa are shown in Fig. 4. This SEM images show clearly the effect of pre-irradiation thermal treatment on bending property after irradiation. For recrystallized Mo, crack does not initiate or propagate along the direction of the loading support. It indicates that the specimen fractured totally in brit-

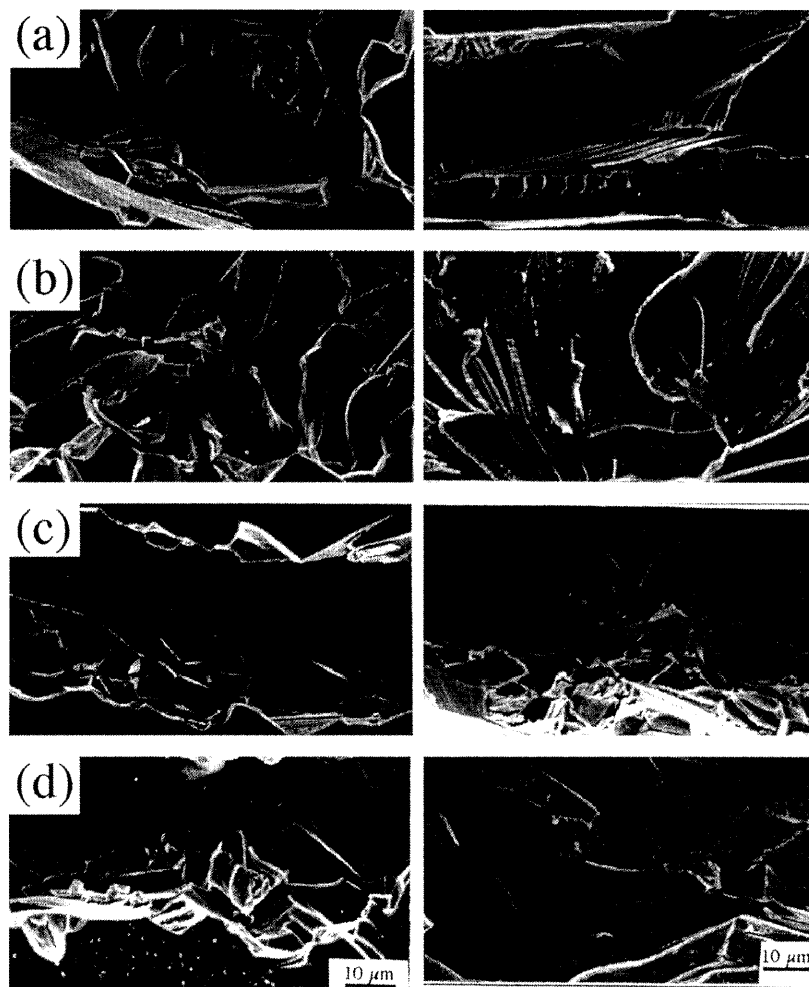

Fig.5 Fractography of recrystallized Mo (in left column) and TZM (in right column) irradiated in (a) 406 °C/27dpa, (b) 519 °C/34dpa, (c) 600 °C/34dpa and (d) 800 °C/11dpa.

tle manner. For stress-relieved Mo, the specimen bent along the direction of the supports, and plastic deformation before fracture was observed from the SEM image.

Fractography of irradiated Mo/R and TZM/R are shown in Fig. 5. Grain boundary fracture is dominant in failure mode of Mo/R, and cleavage fracture of TZM/R.

In Fig. 6, fractography of irradiated Mo/SR and TZM/SR are shown. Typical layered structures were observed in both Mo and TZM. For Mo/SR irradiated in 800 °C/11 dpa, this structure was not observed. Grain boundary fracture was dominant failure mode of this specimen. Partially, intergranular fracture was observed. The grain size was about 10 μ m. It suggests that the grain growth was occurred during irradiation due to high irradiation temperature in Mo.

3.4. The effects of thermal treatments and irradiation conditions on irradiation embrittlement

In bending tests, Mo/SR showed ductile behavior, which was irradiated at from 373 °C to 600 °C. However Mo/SR irradiated at 800 °C fractured in brittle manner. This would be caused by the grain growth during irradiation at 800 °C. The mechanism of suppression of embrittlement in stress relief condition could be due to the grain-size effect, which is similar to the effect in lower fluence range.⁹ This effect was also observed in tensile property of Mo-5 wt. % Re alloy.¹²

In most of stress-relieved Mo and TZM, the lamellar structure was observed in their fracture surfaces. This structure was thought to be introduced in rolling process to fabricate sheets, from which specimens were prepared. Crack seemed to propagate along the boundaries of layers, not in unique direction of the loading from

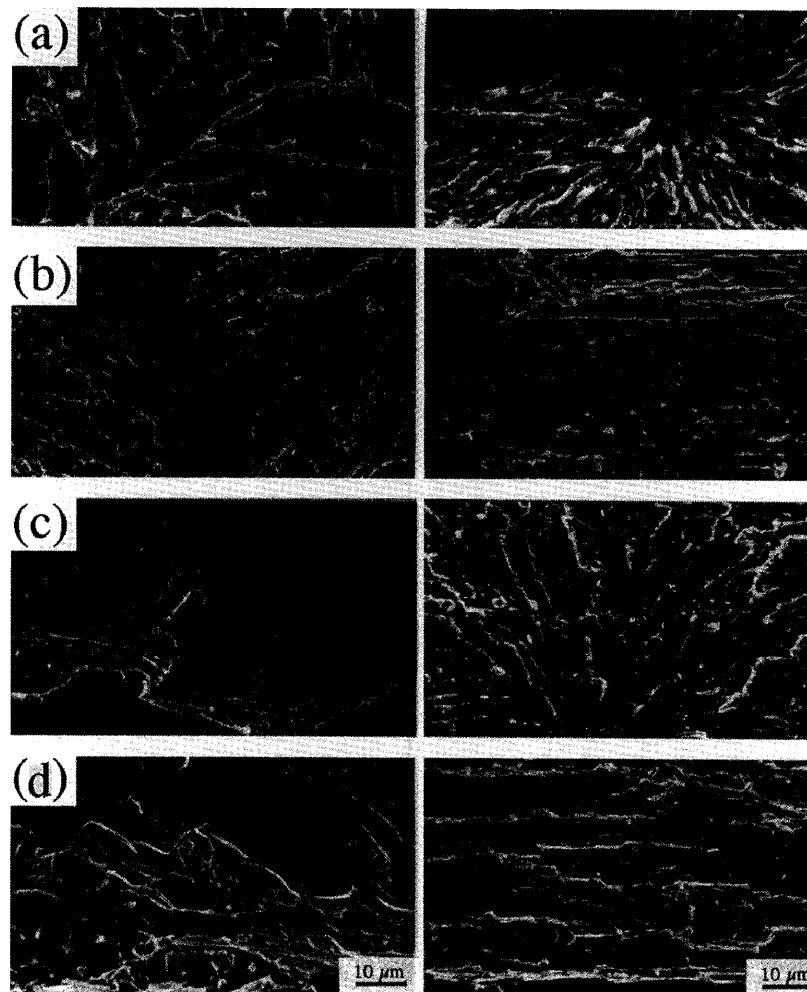

Fig.6 Fractography of stress-relieved Mo (in left column) and TZM alloys (in right column) irradiated in (a) 406 °C/27 dpa, (b) 519 °C/34 dpa, (c) 600 °C/34 dpa and (d)800 °C/11 dpa

fractography. Figure 7 is schematic drawing to represent how crack propagates in a layered structure. The layered structure might be obstacle in the propagation of crack by branching.

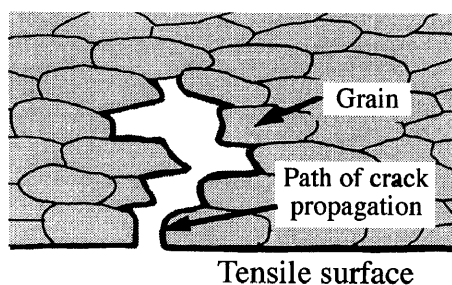

Fig.7 Schematic of fracture of material with layered structure. Crack propagates along a boundary of layers and across a layer.

4. Conclusions

Molybdenum and TZM alloy, which were recrystallized and stress-relieved before irradiation, were irradiated to high fluence level up to 34 dpa. After irradiation, specimens were examined with micro Vickers hardness test and three-point bending test. Bending property after irradiation depends greatly on pre-irradiation thermal treatments and irradiation temperatures. Stress-relief treatment is effective to suppress irradiation embrittlement. Recrystallized Mo and TZM showed brittle behavior after irradiation. For retention of ductility after irradiation at room temperature, it is important to keep fine grain size during irradiation.

References

- [1] S. Nishio, T. Ando, Y. Ohara, S. Mori, T. Mizoguchi, M. Kikuchi, A. Oikawa and Y. Seki, *Fusion Eng. Des.* **15** (1991) 121.
- [2] V.V. Rybin and D.L. Smith, *J. Nucl. Mater.* **191–194** (1992) 30.
- [3] T. Tanabe, N. Noda and H. Nakamura, *J. Nucl. Mater.* **196–198** (1992) 11.
- [4] K. Abe, T. Takeuchi, M. Kikuchi and S. Morozumi, *J. Nucl. Mater.* **99** (1981) 25.
- [5] B.L. Cox and F.W. Wiffen, *J. Nucl. Mater.* **85&86** (1979) 901.
- [6] M. Tanaka, K. Fukaya, K. Fukai and K. Shiraishi, *ASTM STP 725* (American Society for Testing and materials, 1981) 247.
- [7] F.W. Wiffen, *Defects and Defect Clusters in BCC Metals and Their Alloys* (National Bureau of Standards, Washington, D.C., 1973) 176.
- [8] T.H. Webster, B.L. Eyre and F.A. Terry, *Irradiation Embrittlement and Creep in Fuel Cladding and Core Components* (British Nuclear Society, 1973) 61.
- [9] K. Abe, M. Kikuchi, K. Tate and S. Morozumi, *J. Nucl. Mater.* **122&123** (1984) 671.
- [10] A.M. Ermi, L.R. Greenwood and H.L. Heinisch, *Irradiation Parameters for the FFTF Materials Open Test Assemblies from 1983 to 1992, WHC-SD-FF-TD-010* (1994).
- [11] F.A. Garner, L.R. Greenwood and A.M. Ermi, *Fusion Reactor Materials, Semiannual Progress Report for Period Ending, March 31, 1992, DOE/ER-0313/12* 54.
- [12] A. Hasegawa, K. Abe, M. Satou and C. Namba, *J. Nucl. Mater.* **225** (1995) 259.